

ПОДДРЪЖКА ЗА СТЕННО МОНТИРАНЕ

Код за поръчка	Д mm	Д mm	В mm	ТЕЖЛО (кг/бр) (L)	ТЕЖЛО (кг/бр) (L1)	
A6-05	60	1.50	90	0.045	0.050	100
A6-10	130	1.50	90	0.180	0.200	100
A6-12	130	1.50	90	0.180	0.200	100
A6-16	170	1.50	90	0.200	0.220	100
A6-20	210	1.50	90	0.240	0.270	100
A6-30	310	1.50	120	0.395	0.435	50
A6-40	410	2.00	140	0.755	0.830	
A6-50	510	2.00	140	0.990	1.090	
A6-60	610	2.00	140	1.280	1.410	

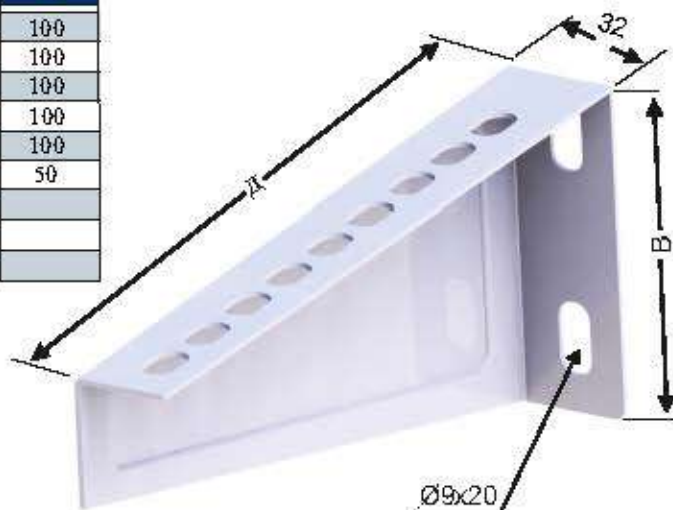

A6-20

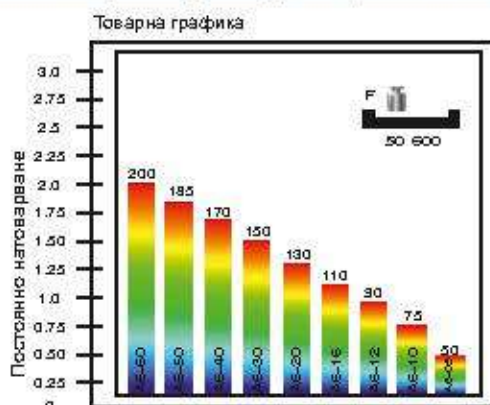

A6-05 / A6-10 / A6-20 Доставка от склад

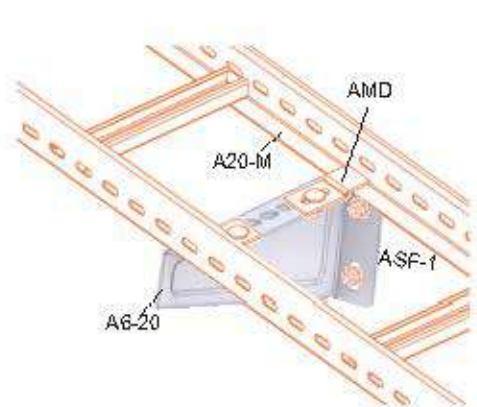

A6-20 Примерна връзка

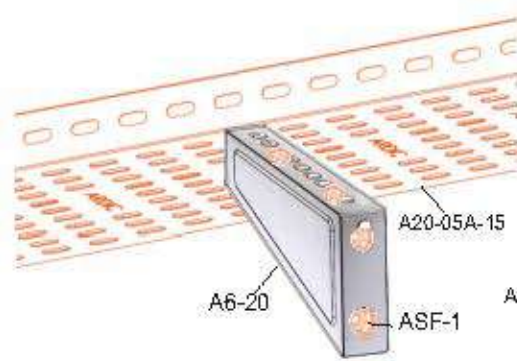

A6-20 Примерна връзка

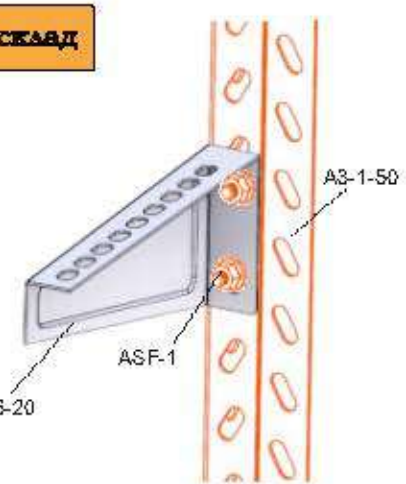

A6-20 Примерна връзка



ПОДДРЪЖКА ЗА СТЕННО МОНТИРАНЕ (ЗАВАРЕНИ)

Код за търсене	Д mm	Д1 mm	Д2 mm	В mm	ТЕЖО (кг/бр)	ЦЕНА (лв)
A6-10K	110	1.50	3.0	110	0.210	70
A6-20K	210	1.50	3.0	110	0.315	70
A6-30K	310	1.50	4.0	150	0.560	35
A6-40K	400	2.00	4.0	150	0.807	35
A6-50K	500	2.00	4.0	150	1.960	
A6-60K	600	2.00	4.0	150	1.300	

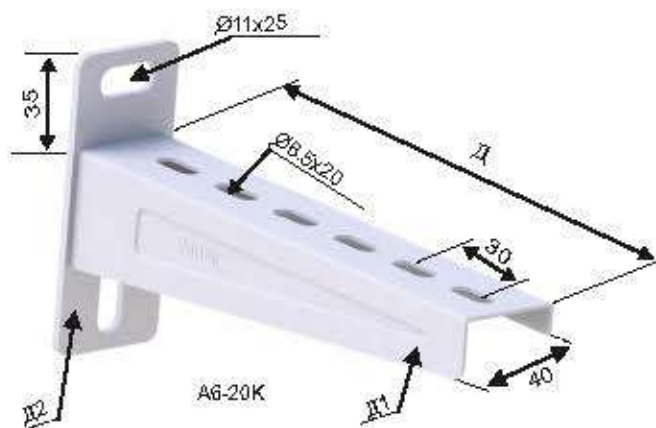

A6-10K / A6-20K / A6-30K / A6-40K. Доставка от склад

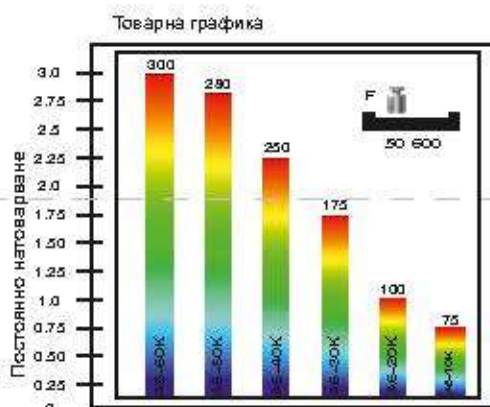

A6-10K/20K
Детайли за базов отвор

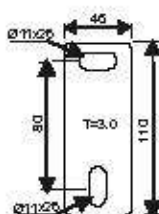

A6-30K/60K
Детайли за базов отвор

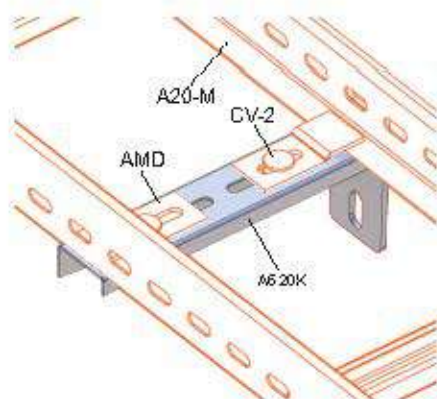
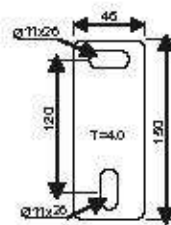

A6-20K Примерна връзка

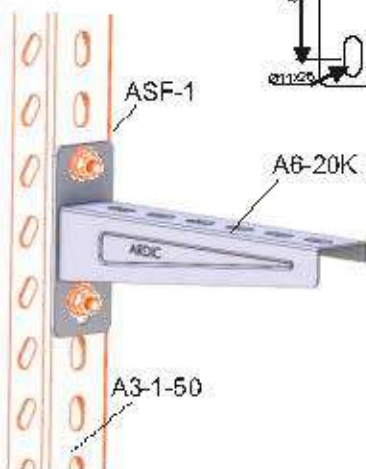

A6-20K Примерна връзка

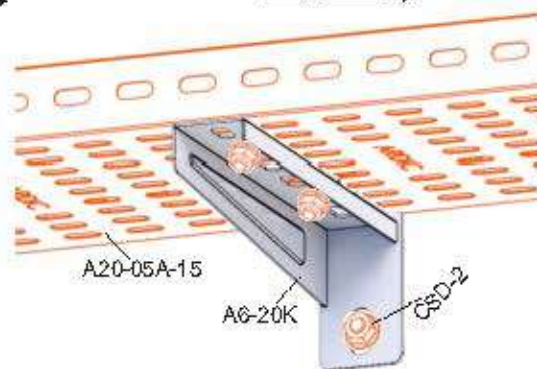

A6-20K Примерна връзка

Носачи за кабелни скари С ТИП (Използва се с резбови отвор)

Код на продукта	В mm	Д mm	Д mm	Д mm	Тегло (kg бр)	
A5-7-10	110	105	67	3.0	0.212	
A5-7-12	110	125	85	3.0	0.233	
A5-7-16	110	165	95	3.0	0.270	
A5-7-20	110	205	117	3.0	0.310	

Технически подробности

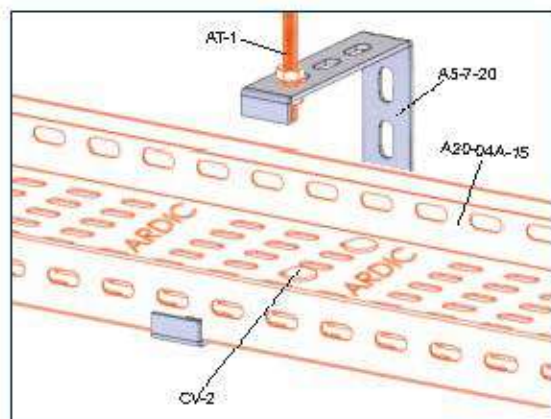
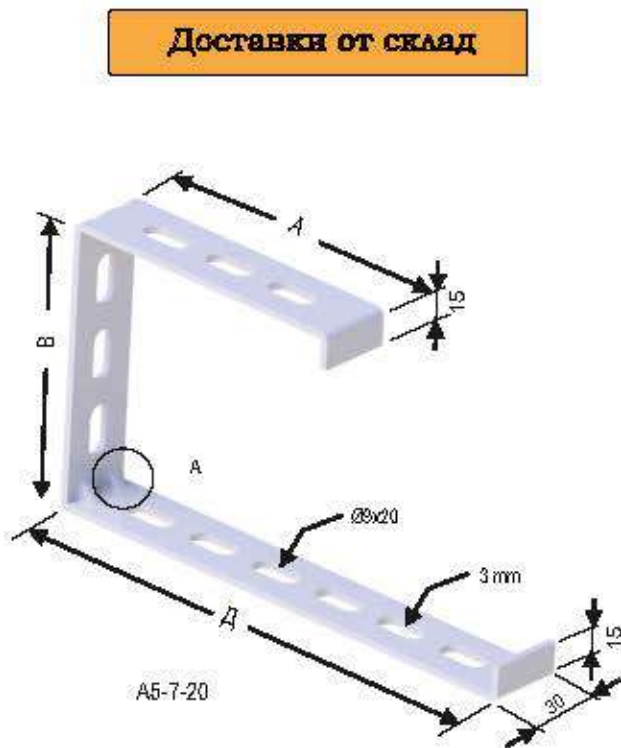
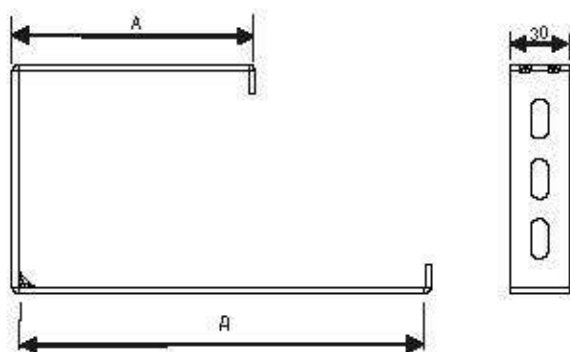

A5-7-20 СПримерна връзка

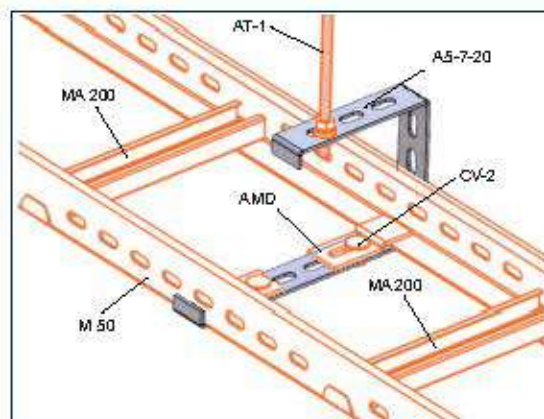

A5-7-20 Примерна връзка

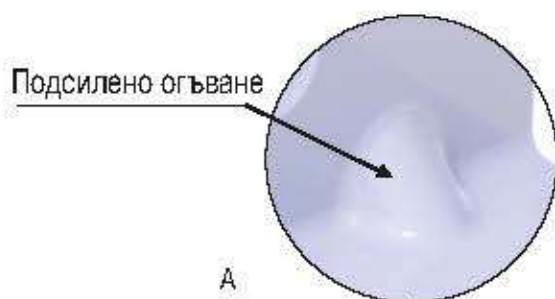

A5-7-20 Примерна връзка